

lumenpulse[™]



lumenbeam[™]
inground

Bury the past, the ingrounds
of the future are here



Ingrounds are looking up

Ingrounds once gave lighting designers pause. Not anymore. Lumenpulse has ushered the inground into the future. Reliable. Impenetrable. Ready for anything. Anywhere.

Install simplicity

Our quick connect system's ease makes miswiring a thing of the past. Spend time on the photometric layout, and less on the installation.

Durable stability

Be it Saigon, Las Vegas, Vladivostok or St. John's, our factory sealed, corrosion-resistant optical chamber, IK10, IP68 ratings and structural blackout can take it.

Outperforming

Our distributions achieve superior visual comfort without forsaking performance. Seeing is believing. Our engineering focuses on true quality of light.

Ample adjustability

On-site 15° tilt and 360° rotation without the need to open the optical chamber means the Lumenbeam Inground's electronic integrity is never subject to the elements.

Future friendly

Interchangeable controls and a separate power supply give you sustainability. Regardless of what tomorrow may bring, these ingrounds are in for the long haul.



Install simplicity

Spend more time on the things that matter and less money on the things that don't. Our quick connect system makes miswiring a thing of the past. That's right, miswiring and installation difficulties are nearly obsolete. You can now put your energy where it matters.

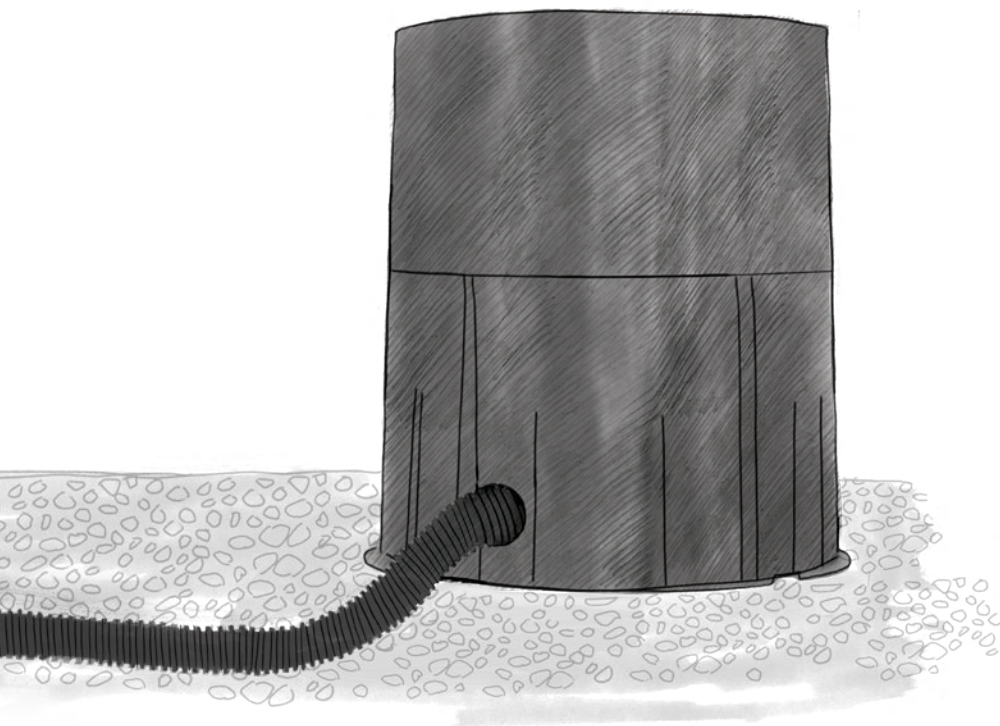

Prepare soil, install blockout, lay down conduits, cables and install JBOX (optional).



1 Simply plug your power (and data) cable into the Power and Control Box (PCBX).



2 Plug the luminaire into the PCBX.



3 Easily lower the luminaire into its natural habitat using the built-in straps.



4 Put the stainless steel trim in place.



5 Lock the trim in place using the appropriate driver.



6 Done. And, yes, it is this simple in real life.



Product shown:
Lumenbeam Inground
Large with anti-slip Clear
Glass Lens, Internal Louver
and Flush Trim



Durable stability

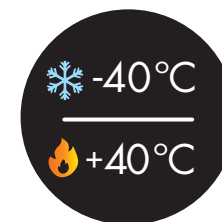

A factory sealed, corrosion-resistant optical chamber, structural blackout, a 5000 kg drive-over rating with IEC60598-13 compliance, IK10-rated lens, IP68-rated optical chamber and Power and Control Box, as well as a harsh environment brass housing means that failure is the only unavailable option. Never mind what you think you know, the Lumenbeam Inground is tough on weather.

IK10
IK10 is the world's highest rating against impacts for luminaires and electrical enclosures.

Consult factory for -40°C to 50°C temperature range.

Outperforming

If you think being an inground limits this Lumenbeam, think again. Inside are all the bells and whistles you've come to expect from the Lumenbeam family. This inground is ready to help your designs change how we see the world one installation at a time.

The Lumenbeam Inground surpasses other ingrounds in every measurable way. This inground provides best-in-class performance; with enhanced digital control and dimmability; long-term energy and maintenance savings (L70 B50 at 25°C = up to 370,000 hrs); high-output capabilities; exceptional color rendering and consistency within a 2-step MacAdam ellipse.

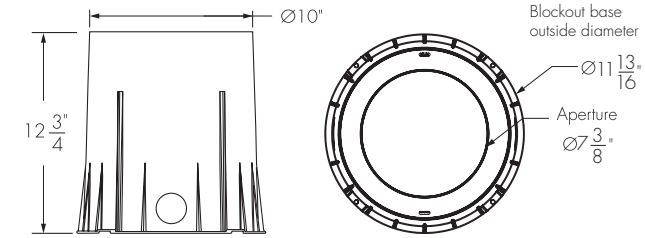

OPTICS

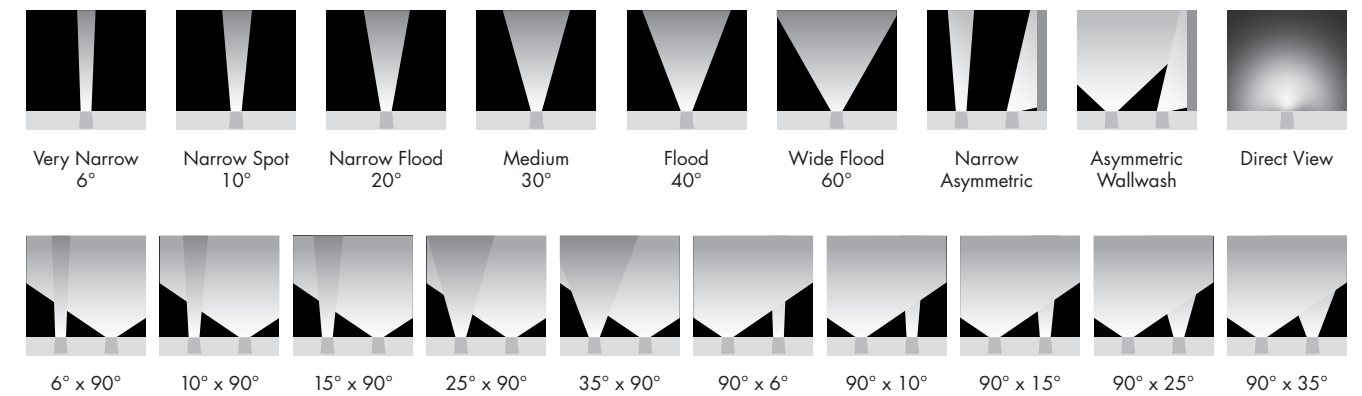

COLORS AND COLOR TEMPERATURES

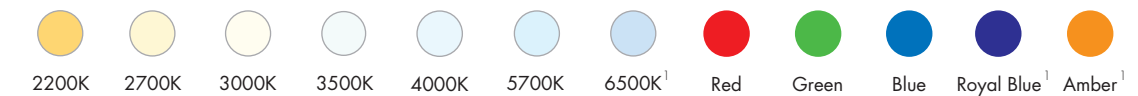

CONTROLS



CERTIFICATIONS AND RATINGS



CONSTRUCTION

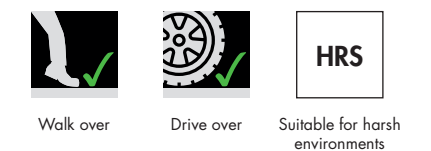

¹ Consult factory for availability of static Royal Blue, Amber and 6500K. Options vary according to model. Consult specification sheets.

Ample adjustability

On-site 15° tilt adjustment and 360° rotation without having to access the interior of the optical chamber, or remove the fixture from the blockout, means the electronic components of the Lumenbeam Inground are never subject to the elements.



ROTATE
360°



TILT
+15° to -3°



LOCK
Tamper-proof
hardware

Visual tranquility

The Lumenbeam Inground is something to look up to. We miniaturized the technology in order to maximize the output when tilting with wide beam angles. We have also designed a custom internal louver for superior visual comfort.

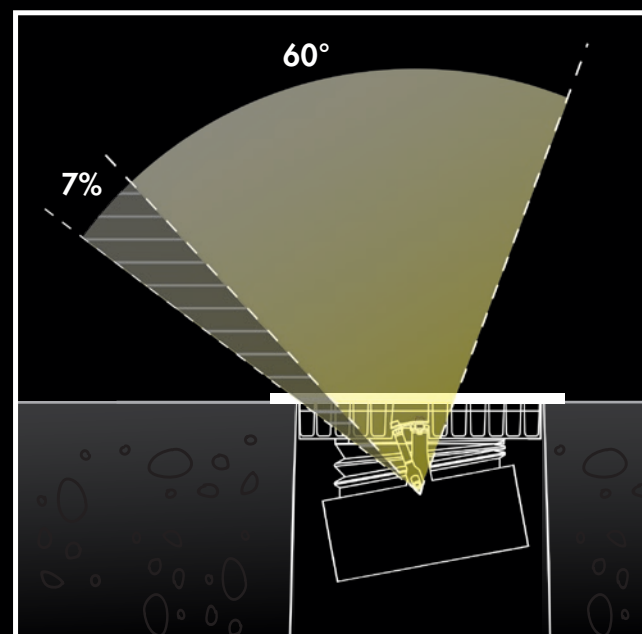

We're changing what you thought of ingrounds.
Only 7% light loss on our widest distribution at full-tilt.



Internal Louver (Discrete version)

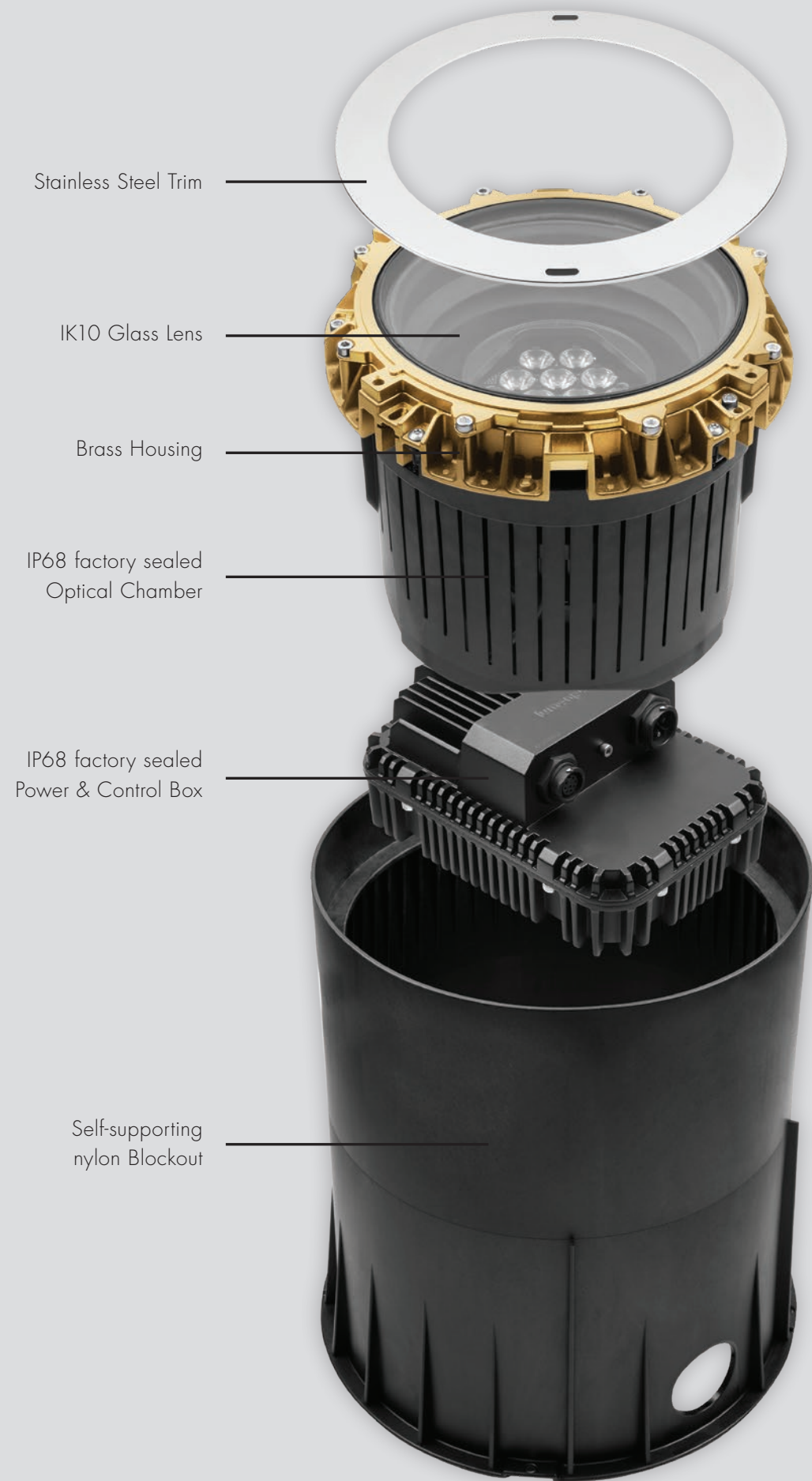

Future friendly

With one eye on the past and another on the future, the Lumenbeam Inground has been designed not only to welcome change with open arms, it has also been built to last with a corrosion-resistant finish and a brass housing. Its modular construction allows components to be changed without changing the whole. This kind of flexibility is the future.



Walk over
1000 kg
(WO)



Drive over
5000 kg*
(DO)



Suitable for harsh
environments
(HRS)



*Must be installed in concrete.
Consult specification sheets for more details.

Astounding optics

Delivering up to 83,330 cd with only 30W (VN, 6°), our Lumenbeam Inground Large delivers enough light to put 1 fc at 288ft, enough to light the top of the Flatiron building in New York. Our engineers optimized each of our distributions – candelas in the narrow beam angles and lumens in the wider beam angles – delivering up to 4,929 lumens at 60W (M, 30°).

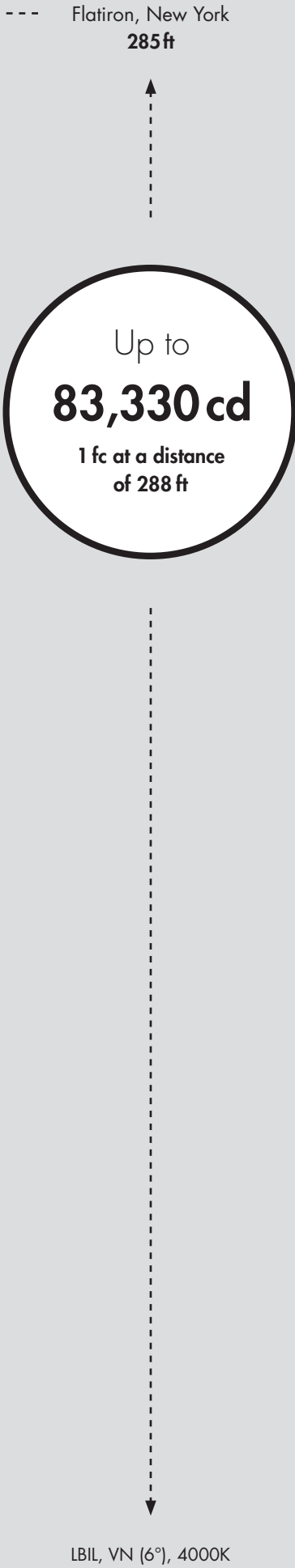

Beating the heat

Having a superb quality of light and best-in-class performance is only possible with the best in heat dissipation. The Lumenbeam Inground's optimized Optical Chamber design allows for the direct and constant contact of the board and the heatsink while allowing a high degree of tilt.

Airflow, which moves through the housing, makes contact with the trim and the external, cooler environment and allows us to manage up to 60 W through the 7 $\frac{3}{8}$ " aperture.

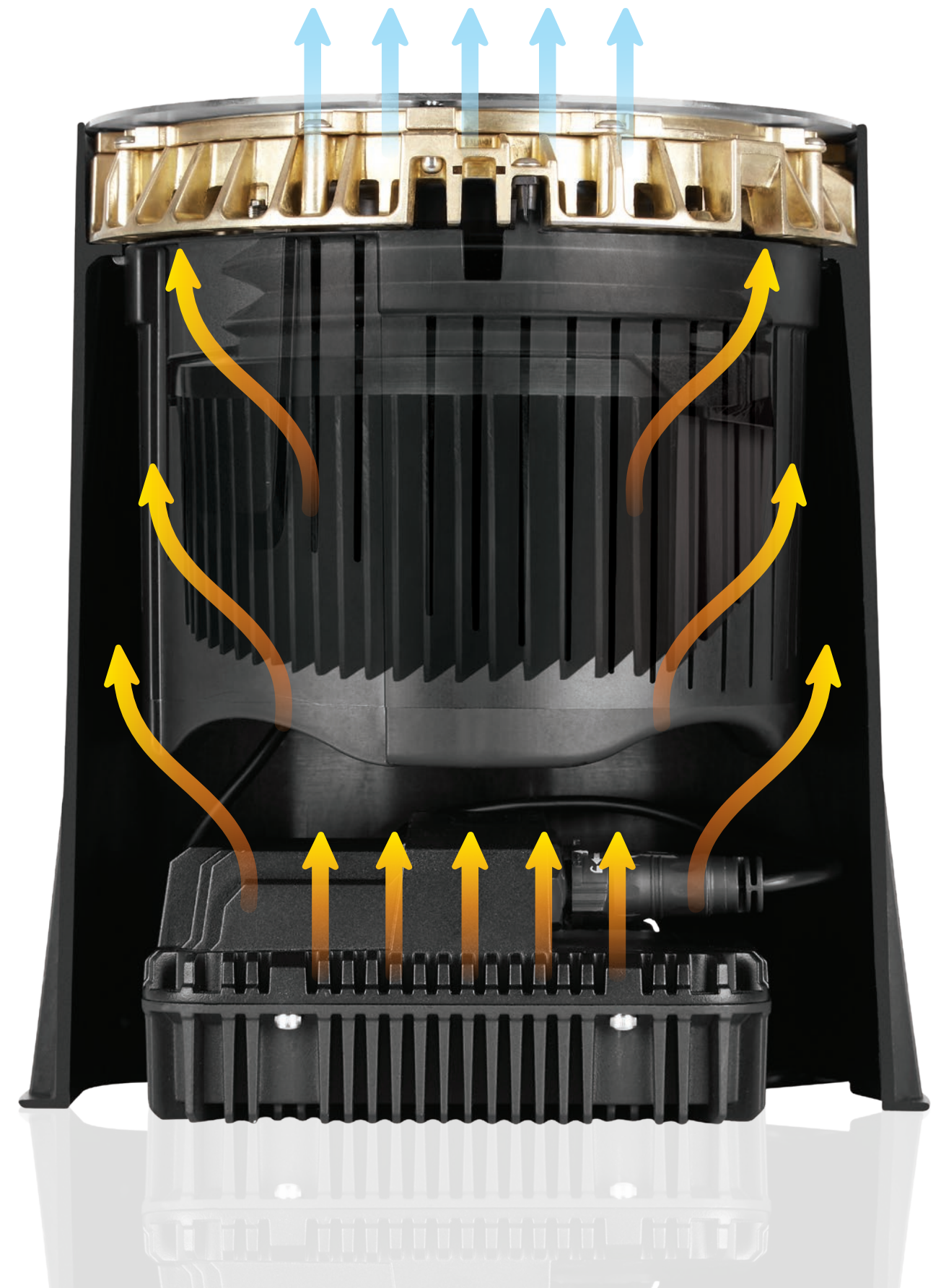



Drive over

The Lumenbeam Inground has a drive-over rating with IEC60598-13 compliance of more than 5000kg when the blockout is in cement. It is able to withstand torque and shear caused by maintenance vehicles starting, stopping and driving over it. Finally, a luminaire that is just as comfortable being underfoot as it is being in the limelight.

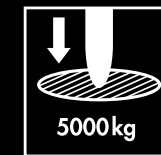

Static load

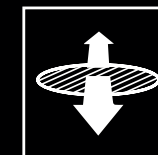

Shear

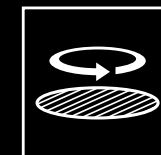

Torque

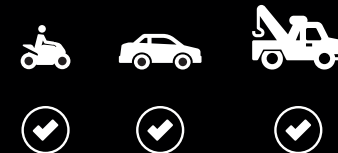

Color-changing dynamics

Your canvas is what you light. The Lumenbeam Inground offers a choice of a Direct View optic, optics for flood or accent lighting, RGB, RGBW or RGBA color mixing, and Dynamic White. All of our Lumenbeam Ingrounds are here to help you bring what you light to life.

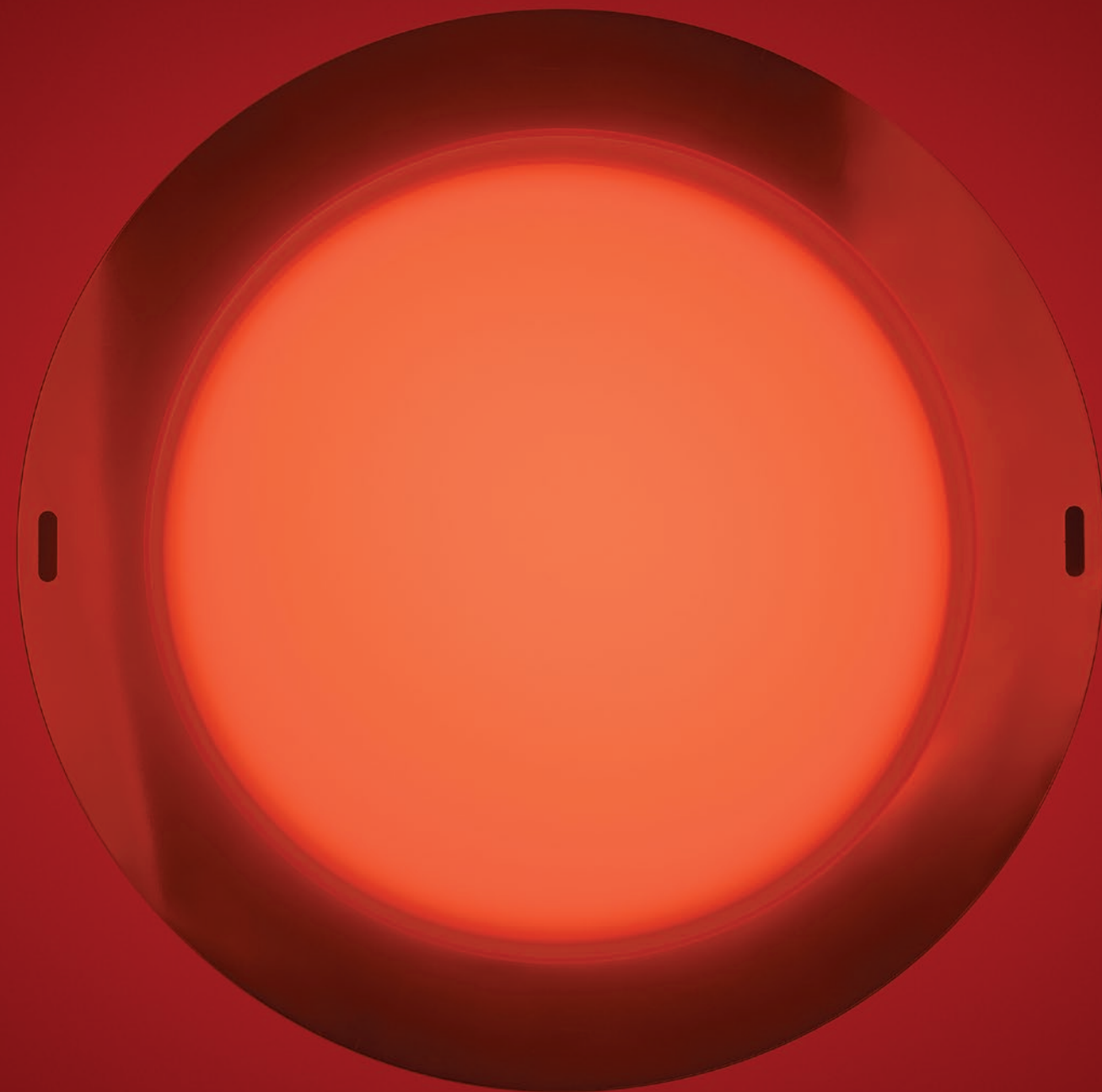



Opticolor supplies a quality of light unlike any other. Color you can feel. Within inches, Opticolor gives you ultra near-field color and beam blending. Opticolor technology boasts in-house, Lumenpulse engineered optics and a multi-chip LED cluster that enables optimized color combinations. This allows you to match existing projects as well as design into the future. You've seen color, now feel Opticolor.

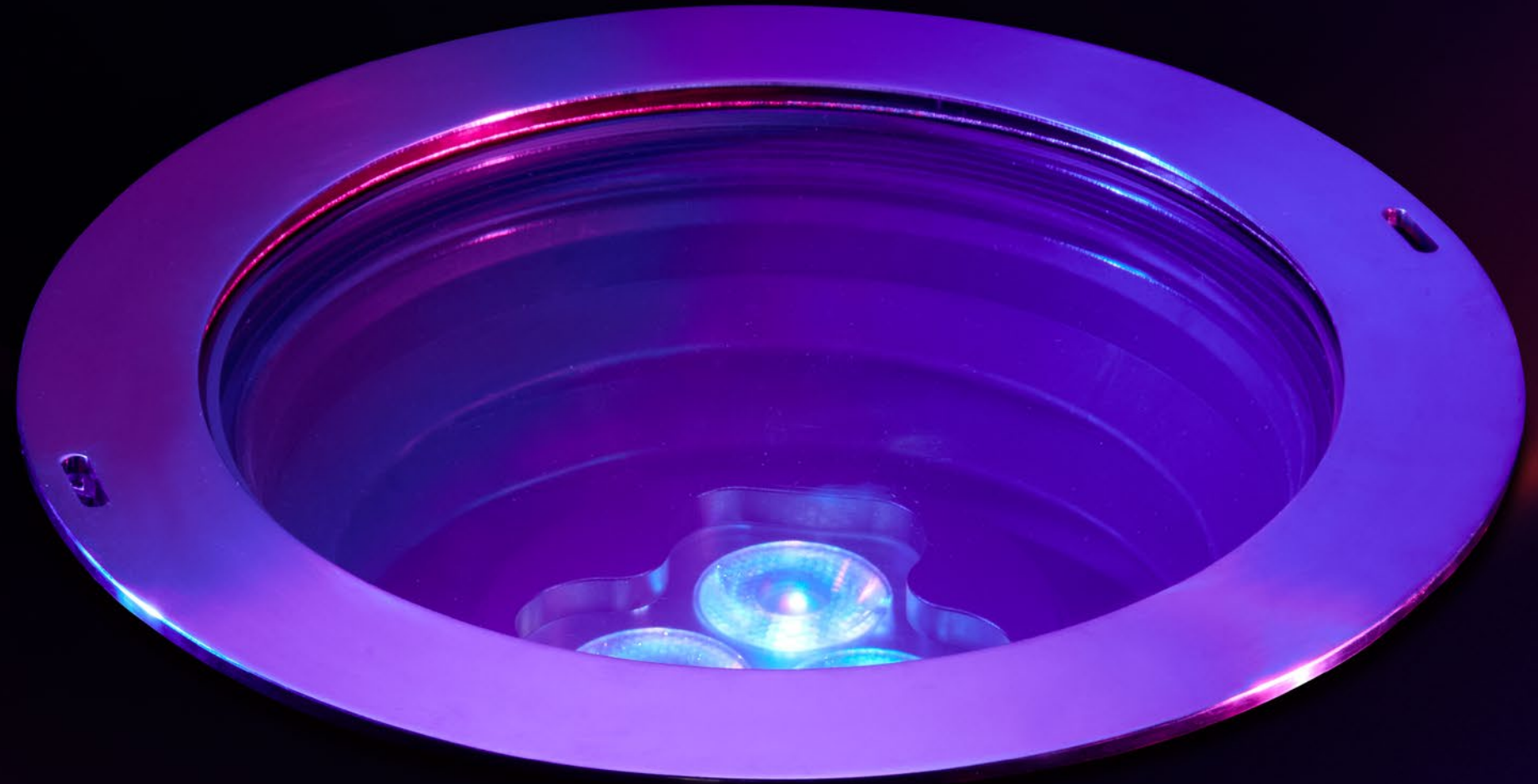

**A New Dimension
of Color**

Lenses + options

Every lens and option has been designed to help you get the most out of the Lumenbeam Inground. Create a signature lighting design that echoes and flatters the architecture, art, or environment you're illuminating.

STATIC WHITE + STATIC COLORS

OPTICS	Clear	Small Frosted Ring	Large Frosted Ring	Opal	Softening
VN			✓		OPTION
NS/M/FL/WFL	✓				OPTION
6°/15°/25°/35° x 90°	✓				OPTION
NAS/WW		✓			OPTION
Direct View				✓	

DYNAMIC WHITE + COLOR CHANGING

OPTICS	Clear	Small Frosted Ring	Large Frosted Ring	Opal	Softening
VN			✓		OPTION
NS	✓				OPTION
M/FL/WFL					✓
6°/10°/15°/25°/35° x 90°	✓				OPTION
NAS		✓			OPTION
WW					✓
Direct View				✓	

*Options vary according to model. Consult specification sheets.

LENSES

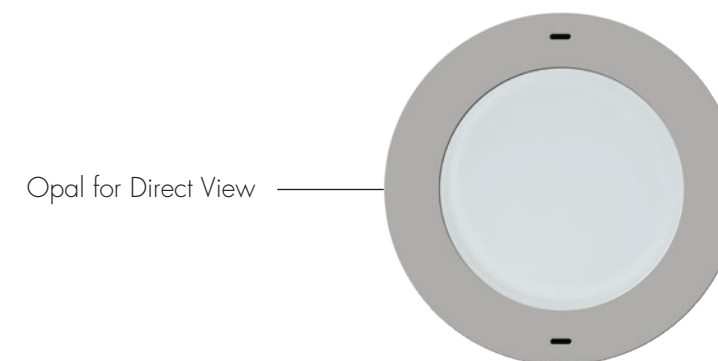
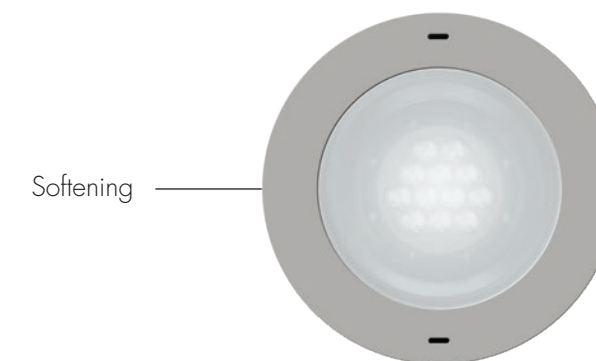
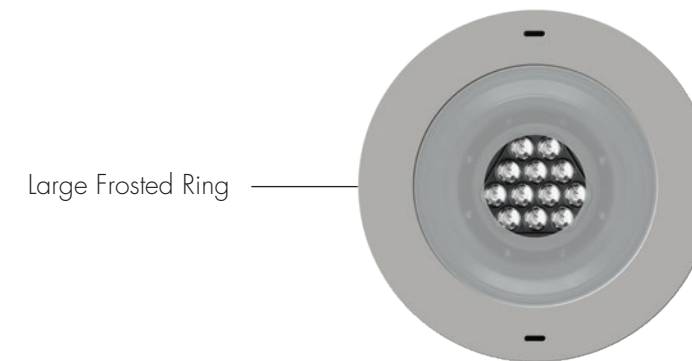
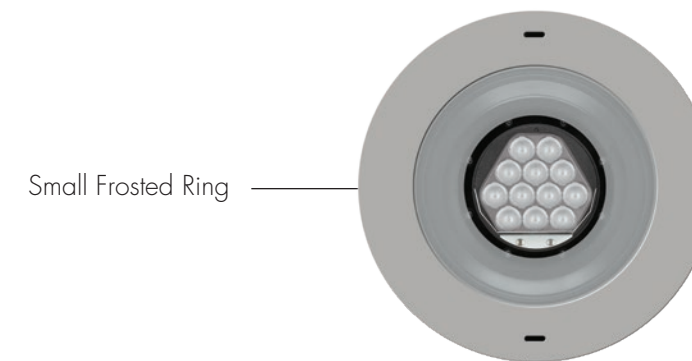

TRIMS

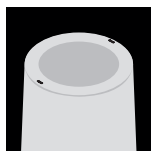

Flush

- No hardware (shown)
- Hardware

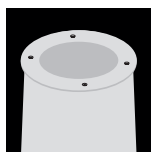

Bevel Edge

- No hardware
- Hardware (shown)



Stainless Steel

- Brushed
- Polished

OPTIONS

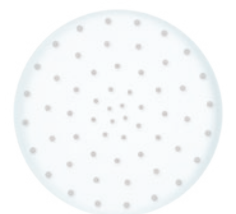

Anti-Slip Lens

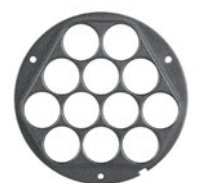

Internal Louver (Discrete version shown)

Optics

The Lumenbeam Inground's optics let you do more than any other inground. Wallwash, Spot, Flood and Direct View help you tune an entire project to your vision.

Performances of Lumenbeam Inground Large 4000K.
 Wattage may vary depending on control option. Consult specification sheets.
 Please consult our website for our complete library of photometric files.



Facades + canopies

Create a soft, uniform wash or an accent of uplight on the undersides of canopies or across facades. Draw the eyes of visitors to architectural highlights or make a space more inviting. The Lumenbeam Inground doesn't get in the way of passersby and is strong enough to withstand a stampede.

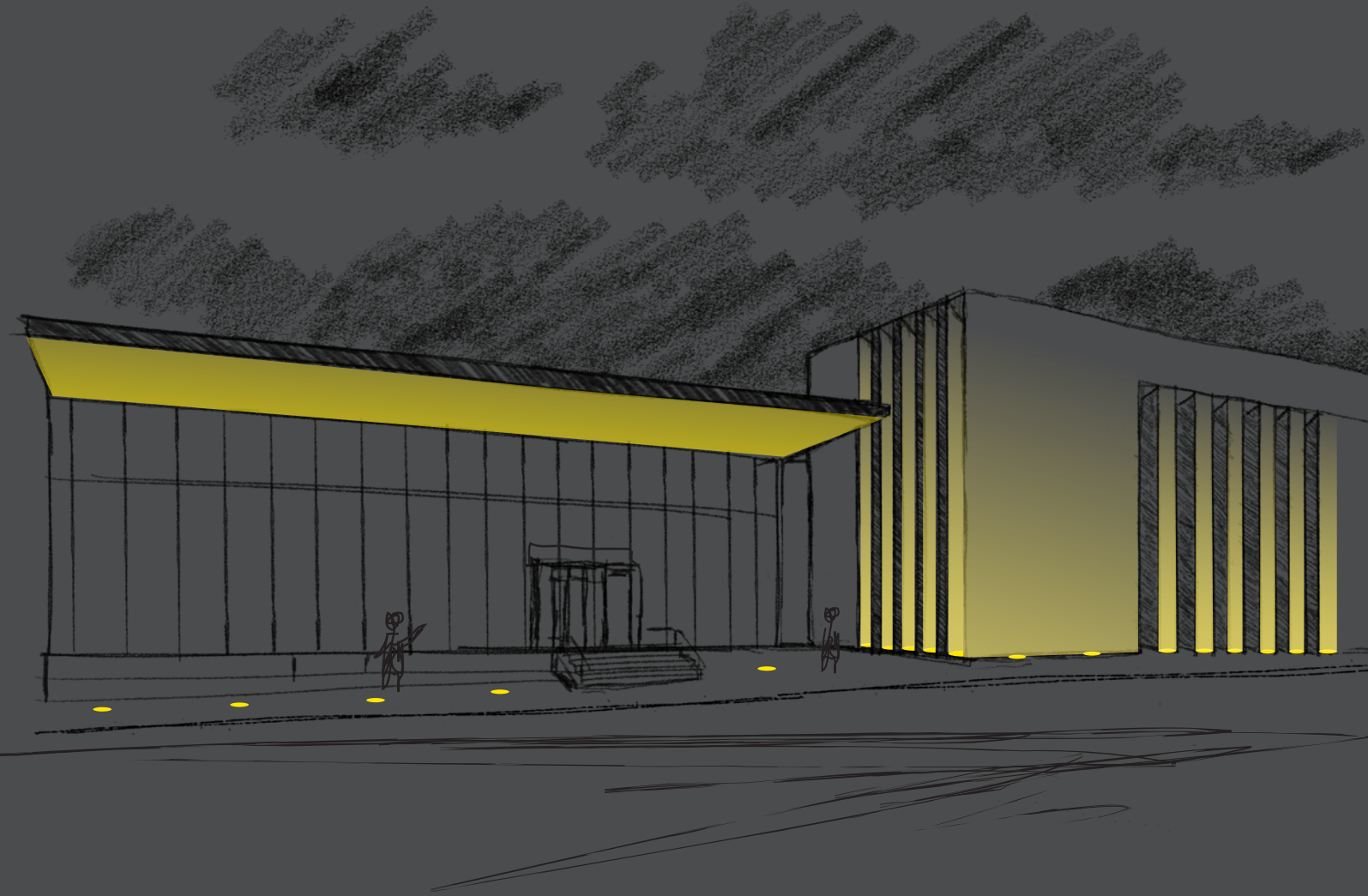

Wallwash lighting

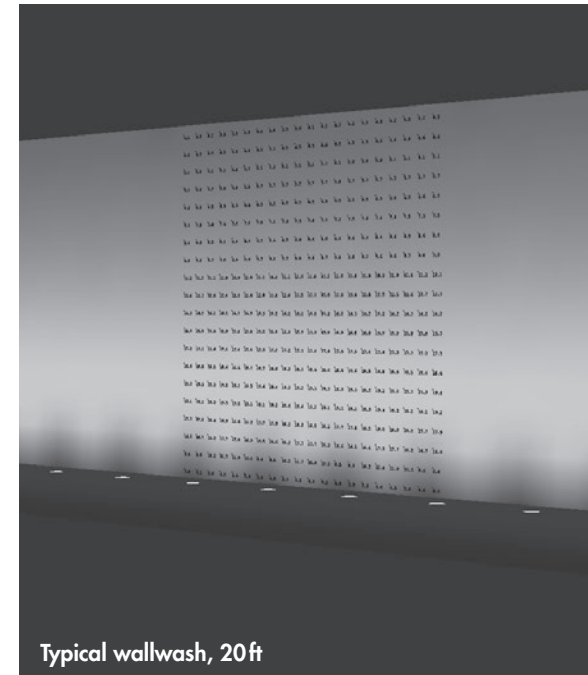

Typical wallwash, 20 ft

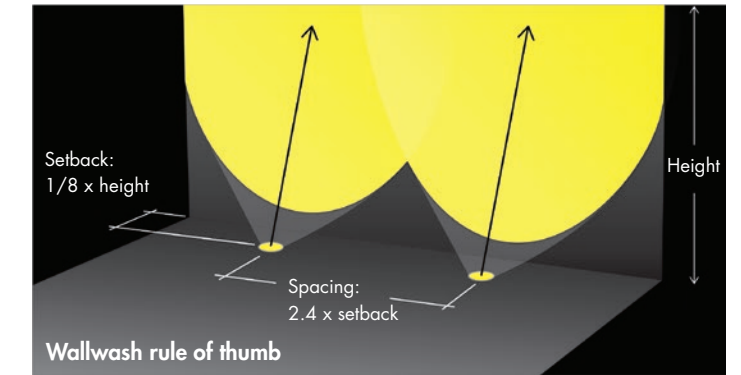

20ft wall

4x Lumenbeam Inground, 4000K,
Wallwash optic, 2,182lm
Setback: 2.5ft
Spacing: 6ft
Avg: 11.5fc
Max/min: 5
Avg/min: 3
1 ft grid resolution

Canopy lighting

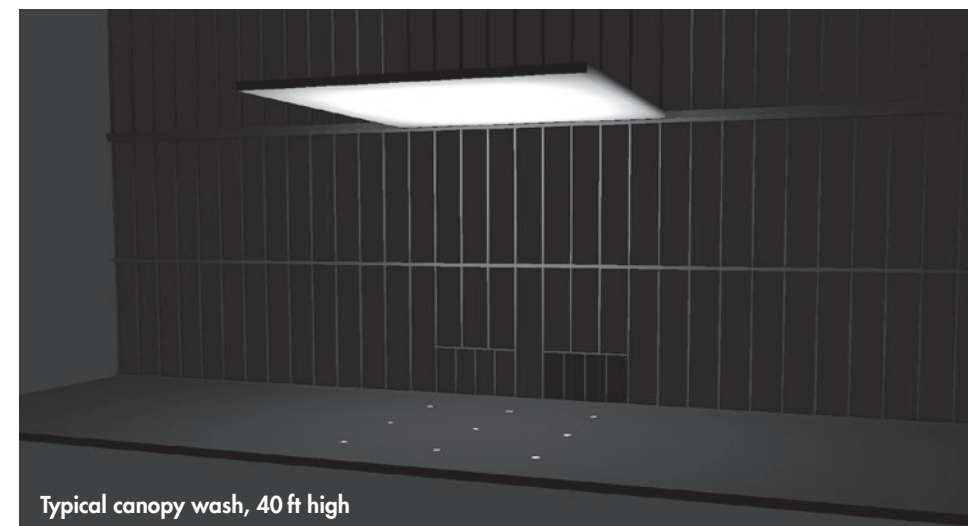

Typical canopy wash, 40 ft high

40ft x 40ft canopy

9x Lumenbeam Inground
4000K, Medium optic
Height: 40ft
Avg: 21fc
Max/min: 7.6
Avg/min: 5.1
1 ft grid resolution

Ground, reflected light

9x Lumenbeam Inground
4000K, Medium optic
Dimensions: 40ft x 40ft
Avg: 1.8fc
Uniformity Max/Min: 1.7
Uniformity Avg/Min: 1.4
1 ft grid resolution

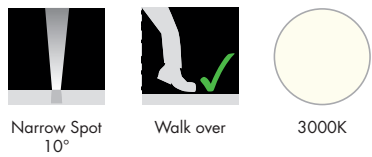

On a 50ft high canopy, use the Narrow Spot distribution with 63,536cd to get 40fc of illumination. This will give you the desired intensity while keeping the chosen surface uniformly lit.

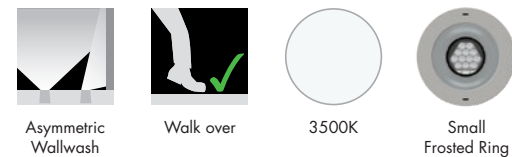
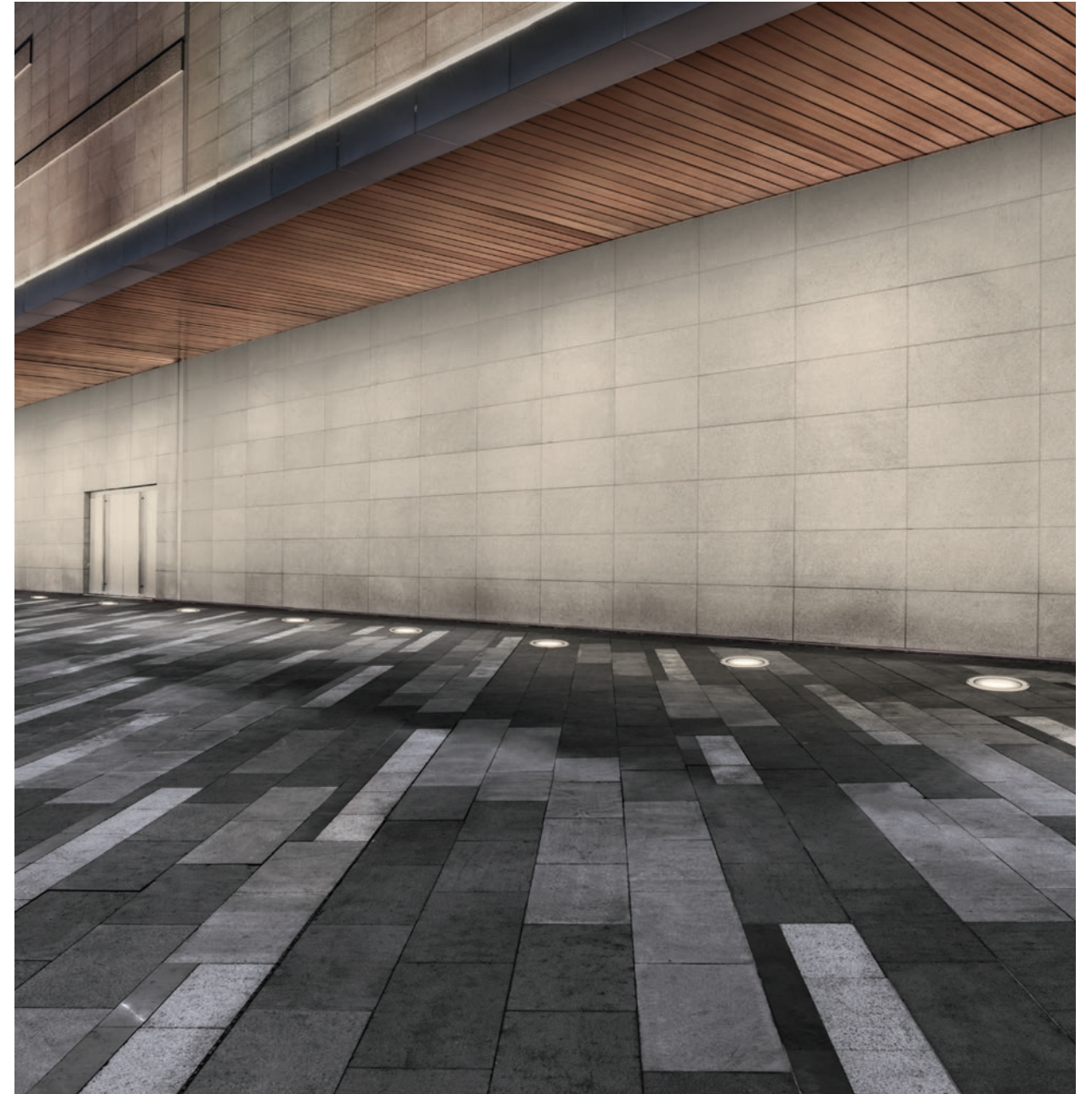

With a setback of only 2.5ft, you can position your Wallwash fixtures very close to a 20ft wall. This ensures that pedestrians are never walking between the fixture and the wall and into the beam. Space your fixtures optimally, two times the setback and get a stellar uniformity of 5:1.

Landscapes

Add layers of light and transform the evening. Create an inviting and safe nightscape and attract visitors. Use light to separate zones, to define a space and create structure within outdoor areas.

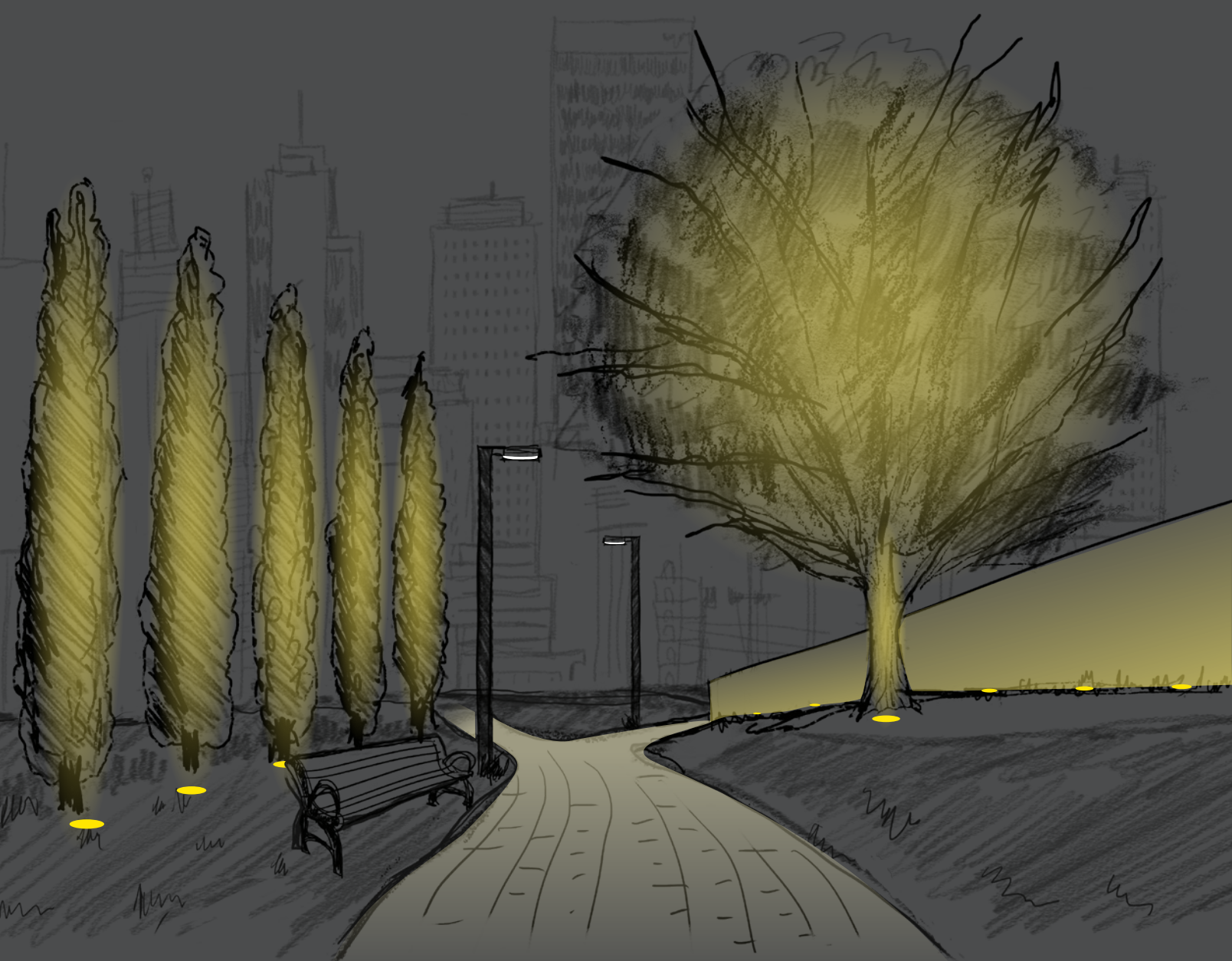

Trees at different growth stages

Our on-site tilt and orientation mechanism allows adjustments without opening the optical chamber so you never need to worry about damaging the fixture components. Adapt your tilt angle to match tree growth. Stay flexible over the years.

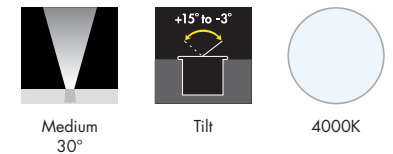

3 ft width x 25 ft height
Setback: 2.5 ft, 1/10 of wall's height
1 ft grid resolution

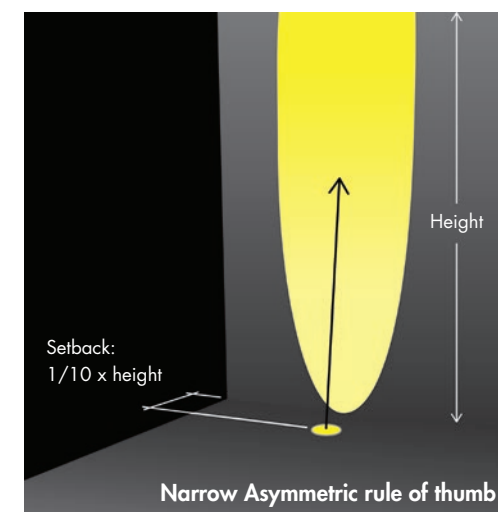

Narrow Asymmetric lighting

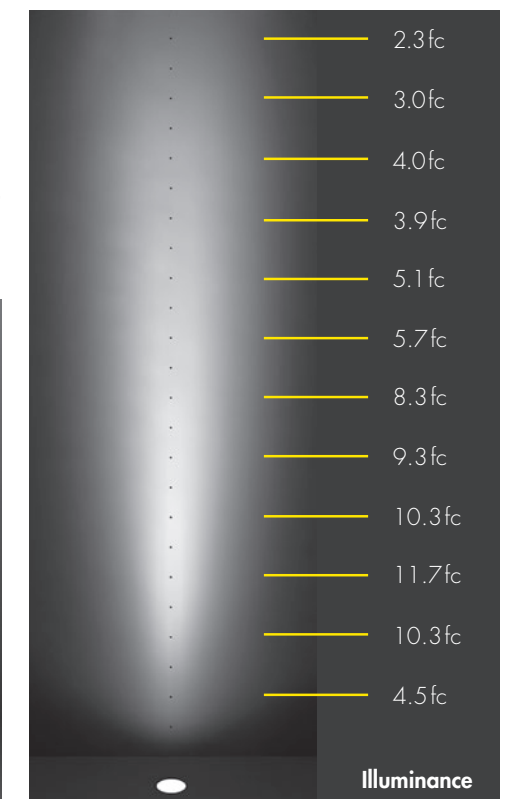



15° x 90°



2200K

Use a 15° x 90° optic to create ellipses of light that frame your facade's details with a great punch of illumination that starts very low and evenly lights upward. Ellipses of luminaires let you graze a wall, emboldening the texture while keeping a minimalist footprint on the ground. Make a reddish brick pop with a 2200K white.

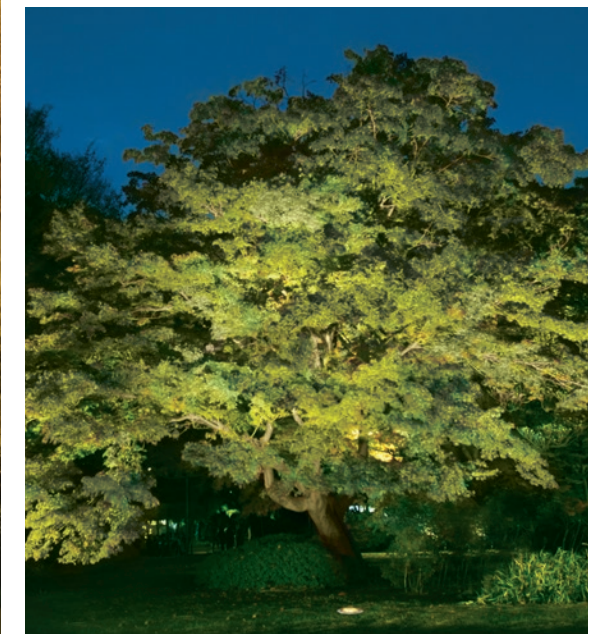

Very Narrow
6°



Flood
40°

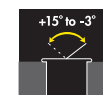

Tilt
+15° to -3°



2700K - 6500K

Keep up with seasonal foliage changes. Dynamic White lets you enhance colored leaves by tuning down to 2700K. But if you want green leaves to be brilliant, you can use a cooler 5000K.

Artwork

Create a lighted focal point out of public art. Make a sculpture a safe and attractive part of the nightscape. Highlight specific details that would otherwise be left in the dark. With the Lumenbeam Inground's optical accessories, the visual comfort of pedestrians is always ensured.

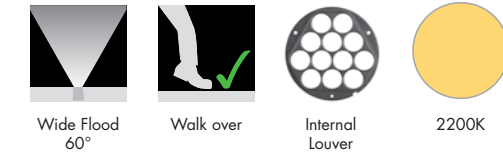
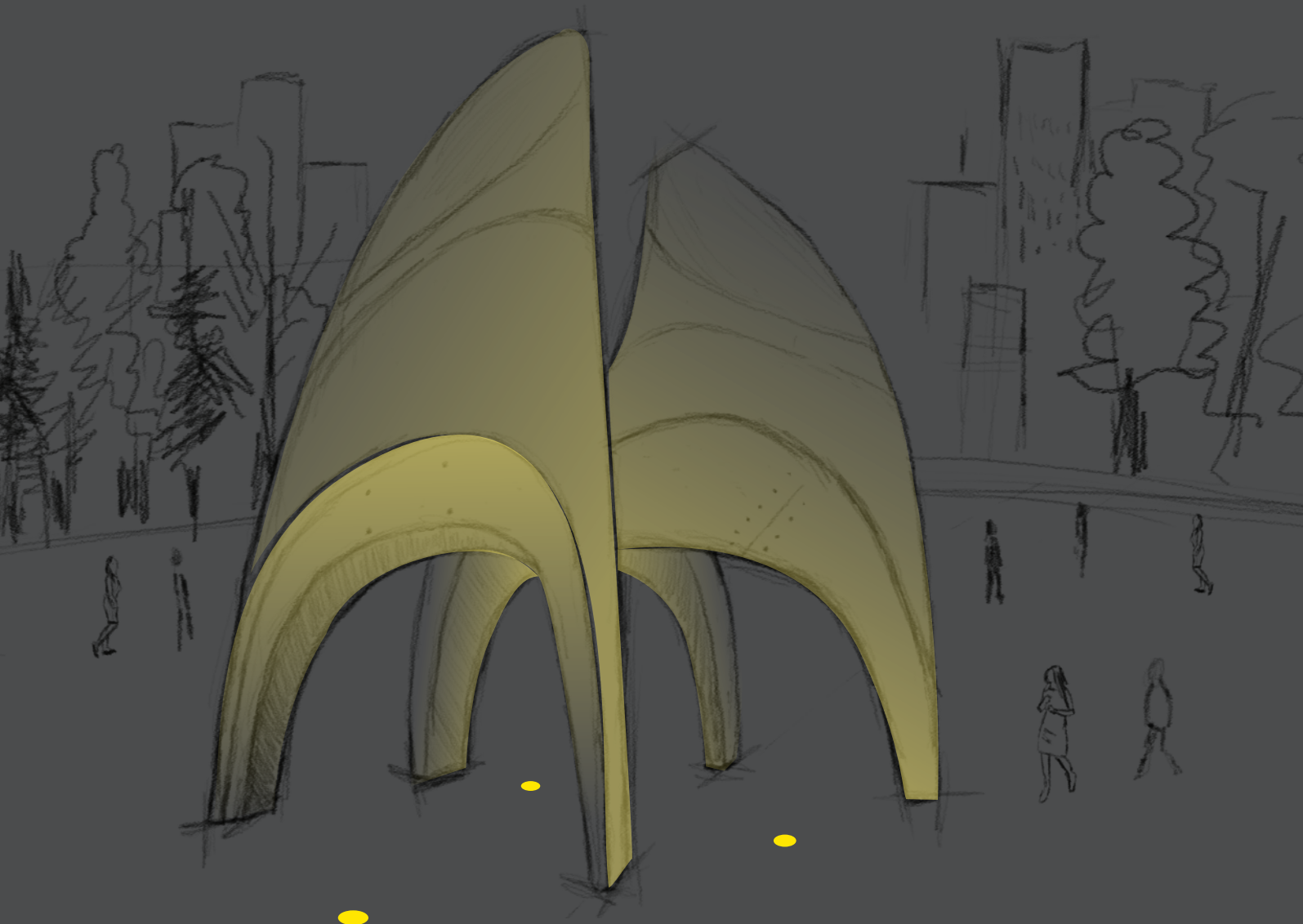

Create a unique dramatic effect by lighting up a sculpture's interior. With flood distributions delivering up to 4,929 lumens, keep the quantity of fixtures to a minimum. Create a bright and even illumination that makes art and architecture unforgettable.



Important architecture is not the place to mount a luminaire. Lumenbeam Inground Large enhances monuments without altering the structure itself while remaining discreet. Choose between our eight standard bi-symmetrical distributions to strongly highlight arches up to 40ft high.

Wayfinding

A well-designed space has the perfect balance of dark and light which allow pedestrians to enjoy illuminated aesthetics while feeling secure. The Lumenbeam Inground is an excellent luminaire to help citizens and tourists find their way and enjoy getting there.

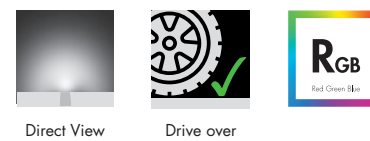

Use color-changing, direct view fixtures to create an artistic effect of smooth and uniform color. Highlight a path in order to guide pedestrians to crossings. Install drive-over rated luminaires wherever there is car traffic, increasing awareness and safety.

Advertising

Let Lumenbeam Ingrounds draw the eye of potential customers while remaining discreetly hidden in the ground. Set your banners and billboards aglow and recognizable from afar.

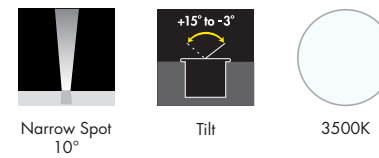
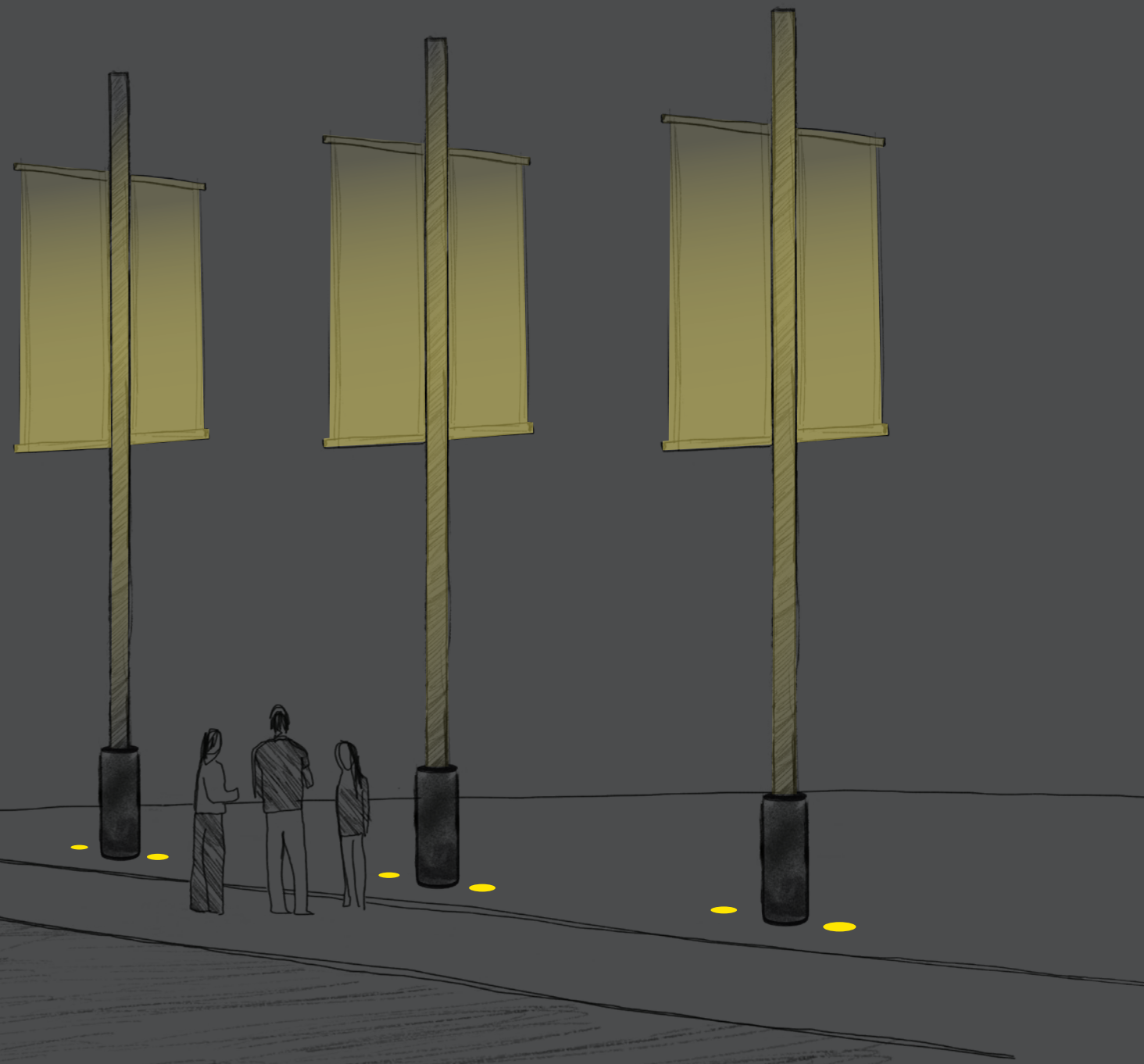

Flagpole lighting

The challenge when lighting flag poles is to ensure that the flag is equally lit in every direction. We recommend installing the fixtures symmetrically and aiming them at 5° at 1/5 of the pole's height. Our Narrow Spot 10° will give you all the reach and intensity you need.

Flagpole lighting

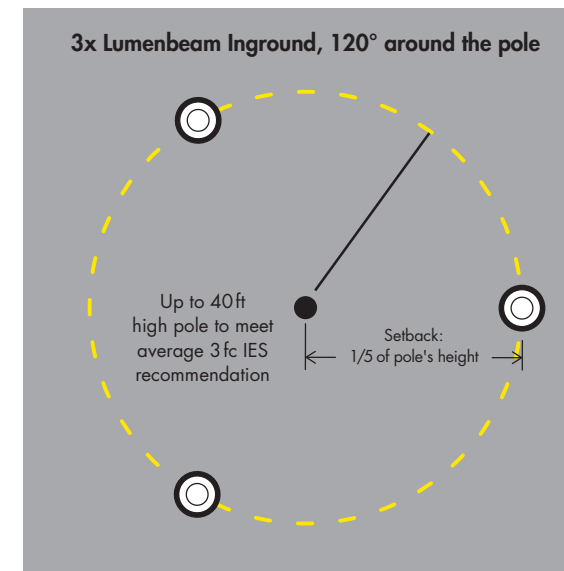

40ft Flagpole

3x Lumenbeam Inground
4000K, Narrow Spot optic,
tilted on-site 5°
Setback: 8 ft, 1/5 of pole's height
Avg: 3.1 fc
Max/min: 6.4
Avg/min: 3.9
1 ft grid resolution

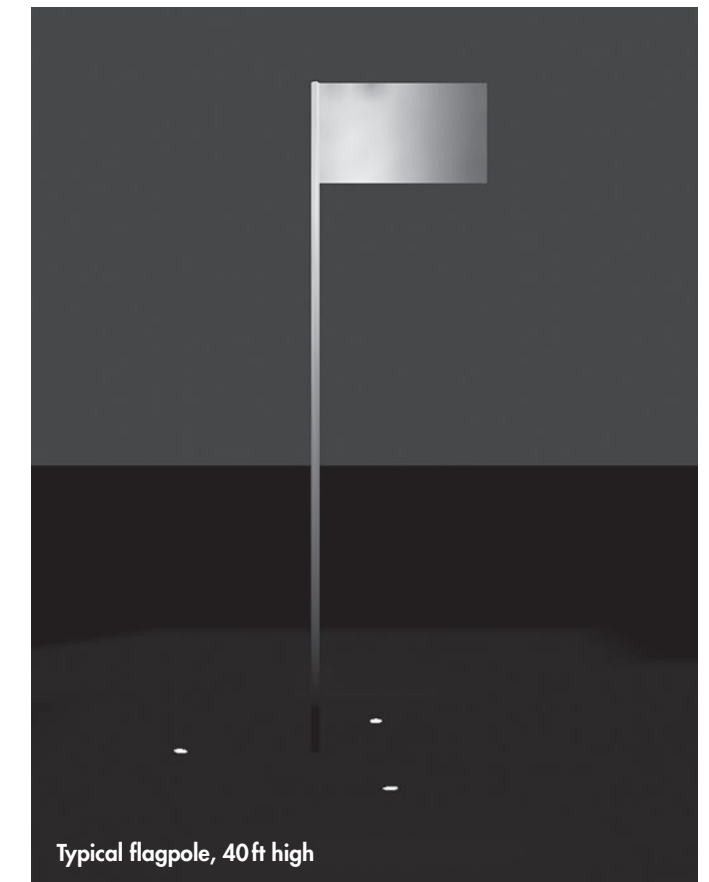



Asymmetric Wallwash



4000K

Advertising Wallwash

With wider panels, use an Asymmetric Wallwash distribution to completely cover wide panels from top to bottom.



Narrow Asymmetric



Softening Lens



4000K

Advertising Narrow Asymmetric

The goal when lighting a banner is to make it stand out from the background and capture attention. For tall and slim banners, use the Narrow Asymmetric distribution, enlarging the width by adding a Softening Lens accessory.

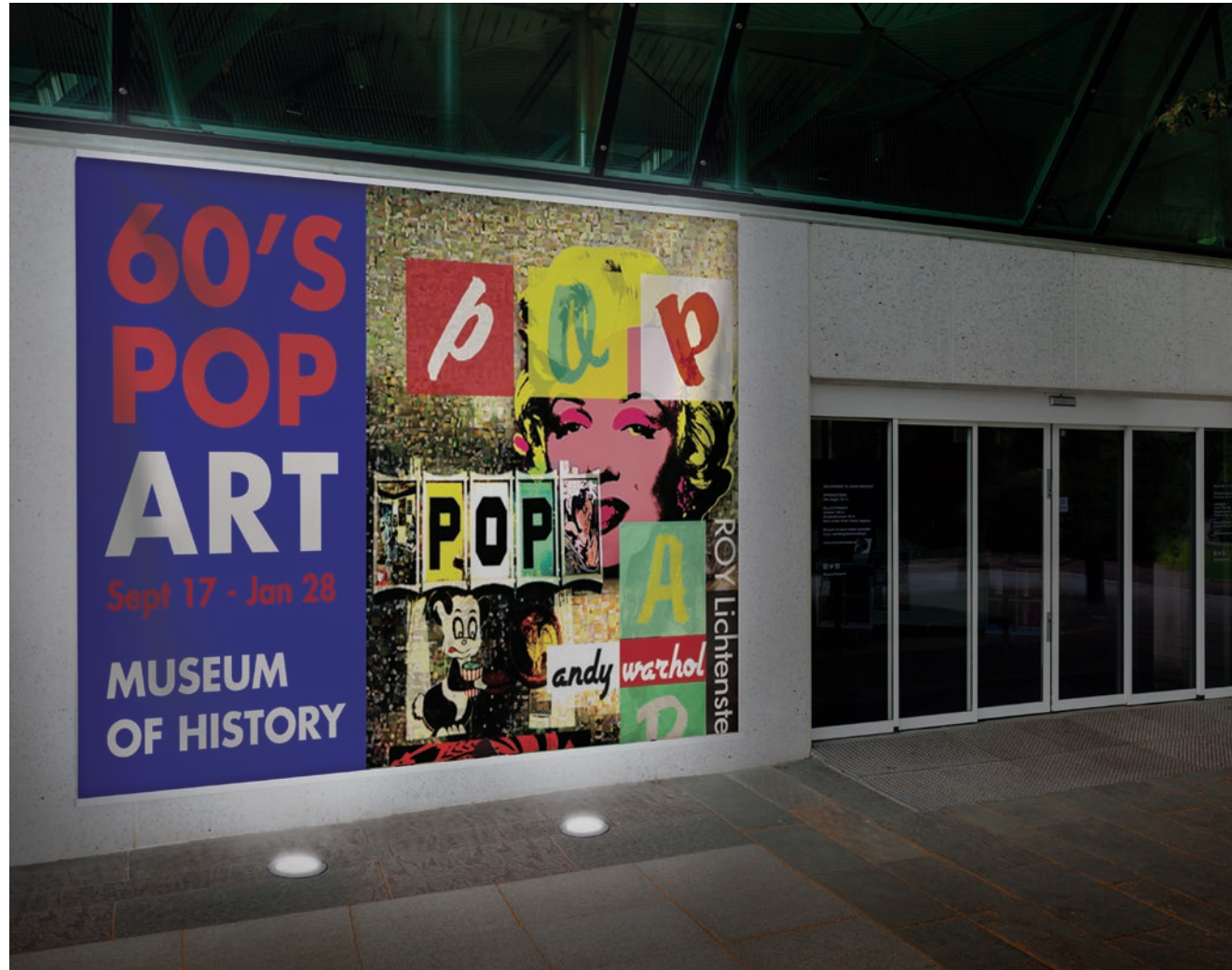

14 ft wide x 10 ft high sign,
1 ft from the ground
2x Lumenbeam Inground, 4000K,
Asymmetric Wallwash optic, 2,183lm
Setback: 2.5ft
Spacing: 6ft
Avg: 11.7fc
Max/min: 6.3
Avg/min: 4
1 ft grid resolution



3 ft wide x 15 ft high sign,
1 ft from the ground
1x Lumenbeam Inground, 4000K,
Narrow Asymmetric optic, 1,715lm
Setback: 2.5ft
Avg: 11.8fc
Max/min: 8.6
Avg/min: 4.7
1 ft grid resolution

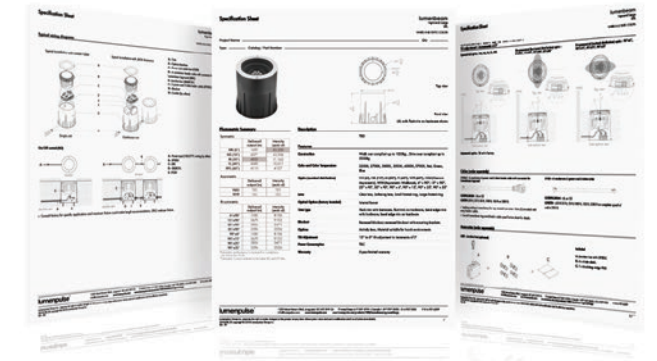

Documentation

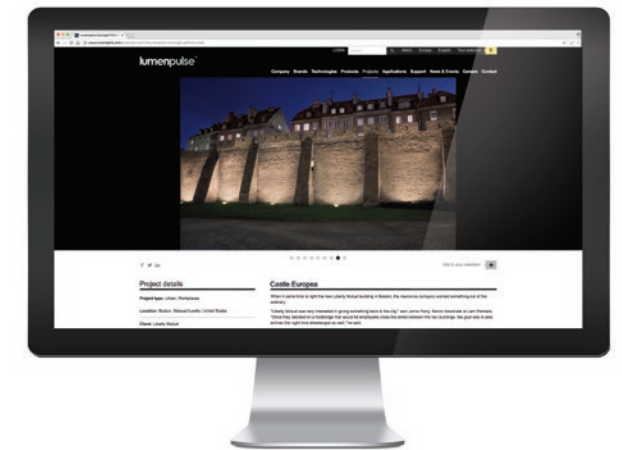

Website

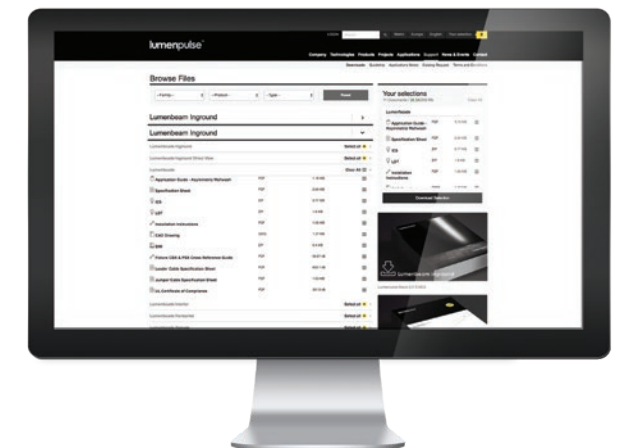

Support files





**Sales Offices and
Manufacturing Facilities**

Corporate Headquarters

1220 Marie-Victorin Blvd.
Longueuil, QC
J4G 2H9 Canada

T +1.877.937.3003
T +1.514.937.3003
F +1.514.937.6289

Boston, United States

14 Beacon Street, Suite 301
Boston, MA
02108 United States

T +1.877.937.3003
T +1.617.307.5700
F +1.617.350.9912

