

lumenpulse™

lumencore recessed
Invisio Wallwash

A Complete Family of Point Source Solutions

Introducing Lumencore's comprehensive range of point source solutions. Rooted in a desire to inspire, Lumencore's performance is built on the same foundational principle that drives your lighting designs. We've expanded upon this core, equipping Lumencore luminaires with various optics, outputs, color temperatures, and aesthetics to fulfill all your point source aspirations, requirements, and practicalities.

Whether you seek Recessed, Cylinders, or Track options, Lumencore has a point source that can be precisely specified for your application. The introduction of the Invisio Wallwash optic enhances our Recessed offerings to meet your diverse needs, providing you with more tools and interior solutions.



Lumencore Recessed



Lumencore Cylinders

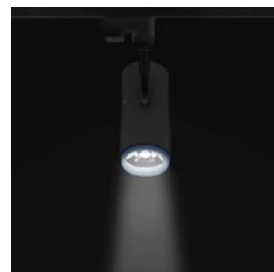

Lumencore Track

| | Square Trimless | Square Trim Square Hole | Square Trim Round Hole | Round Trim Round Hole | Round Trimless | |
|-------------------|-----------------|-------------------------|------------------------|-----------------------|----------------|--------------------------|
| Fixed | | | | | | Standard |
| | | | | | | Mid Deep Recess |
| | | | | | | Deep |
| | | | | | | Deep Rollover |
| | | | | | | Pinhole |
| Adjustable / Tilt | | | | | | Adjustable |
| | | | | | | Fixed Tilt |
| Wallwash | | | | | | Invisio Wallwash |
| | | | | | | Accent Wallwash |
| | | | | | | True Asymmetric Wallwash |
| | | | | | | Double Asymmetric |

Invisio Wallwash is a Transformative Design Tool



Amplifies Perception
of Brightness

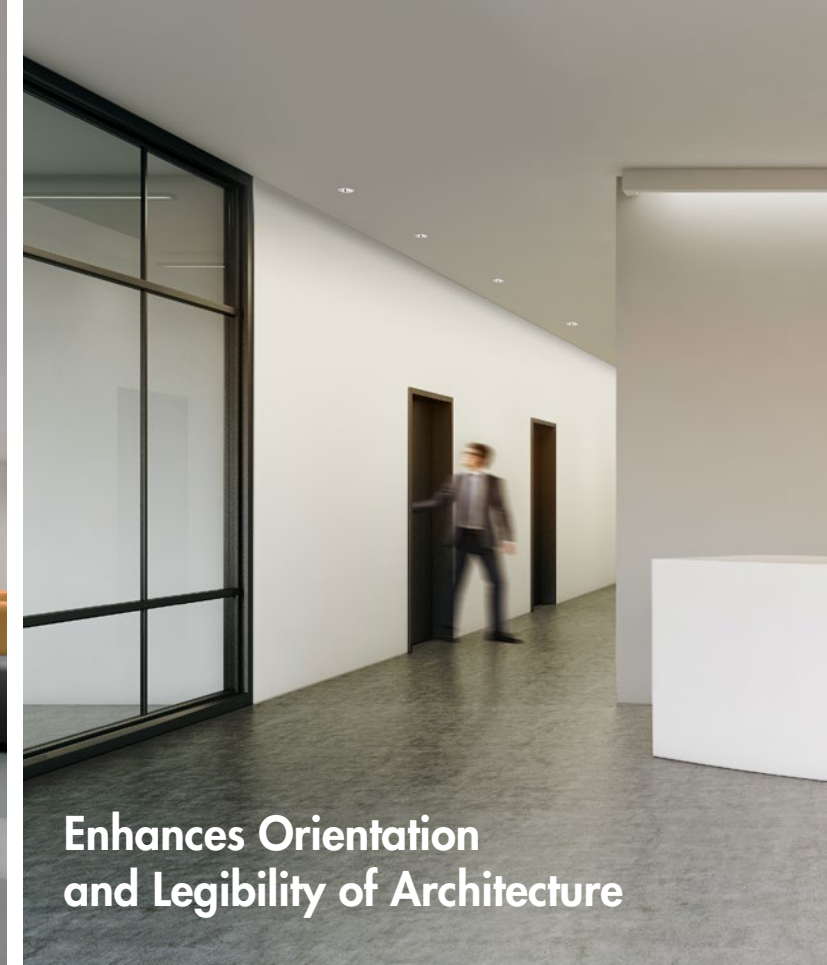

Enhances Orientation
and Legibility of Architecture



Offers Visual Comfort
and Reduces Eye Fatigue

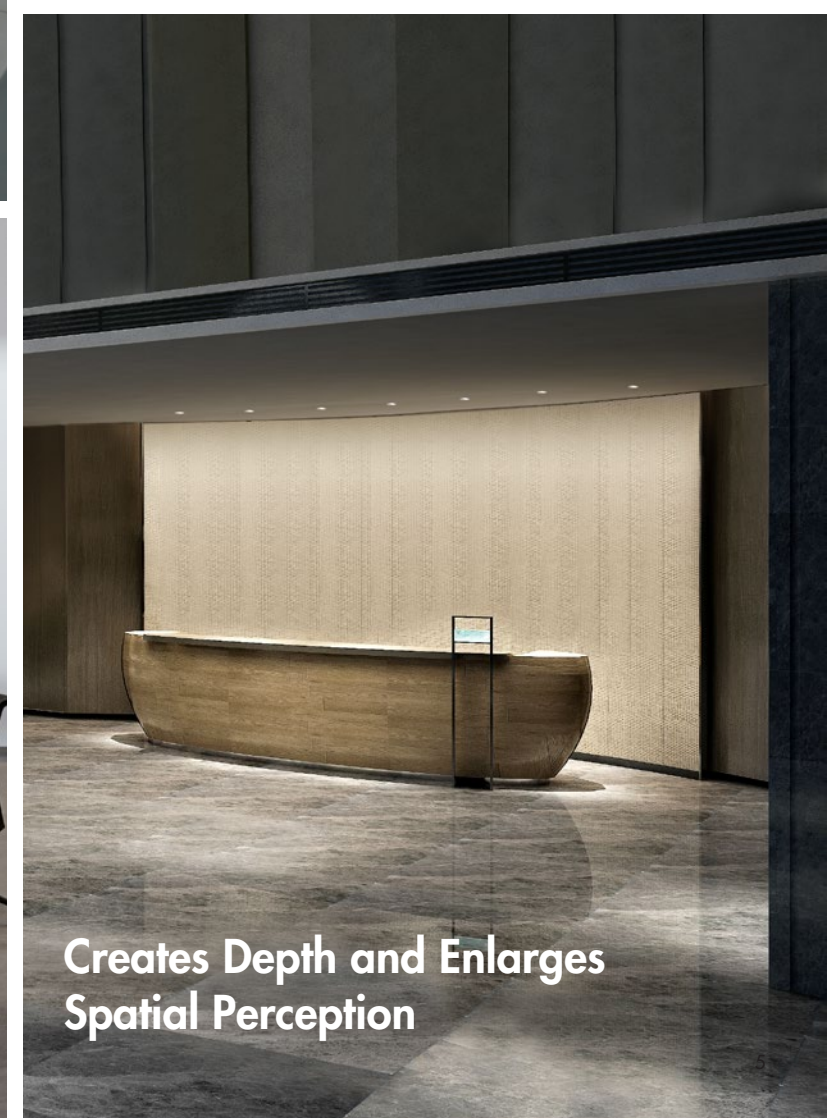

Creates Depth and Enlarges
Spatial Perception

Envisioning Invisio

Designers who have experience with traditional light sources often reminisce about the days when achieving seamless, uniform wallwashing with ample spacing and superior glare control was effortless. Lumenpulse's Invisio does all of this with exceptional efficiency and sophisticated optical control.

- 1 Lights to the Top of the Wall – No Scalloping
- 2 Superb Uniformity, Vertically and Horizontally
- 3 Enhanced Visual Comfort and Low Glare
- 4 Efficient Optics – 90% of Light Targeting Wall
- 5 Greater Spacing and Cost Effectiveness





01 Lights to the Top of the Wall – No Scalloping

Invisio Wallwash covers walls from top to bottom, without scalloping or dark zones, ensuring unparalleled coverage and seamless illumination with less than 2 in of clearance in a room with height of 9 ft.



Uniformity
3 to 1
(Max/Min)

02 Superb Uniformity, Vertically and Horizontally

Experience unparalleled, seamless uniformity between fixtures with Invisio Wallwash. Our advanced technology ensures even illumination vertically and horizontally, far surpassing industry standards of 5:1 (max/min), even when luminaires are spaced generously apart at 4 or 5 ft.





03

Enhanced Visual Comfort and Low Glare

Impeccable visual comfort shifts the spotlight to the beautifully illuminated wall surface, not the luminaire itself. With Invisio luminaires, we've mastered the art of blending into the space seamlessly.

Our design secret lies in the deeply regressed optic set at a sharp 45° angle. This innovative feature ensures that views into the luminaire are completely blocked from over 4ft away, providing a comfortable and glare-free lighting experience.

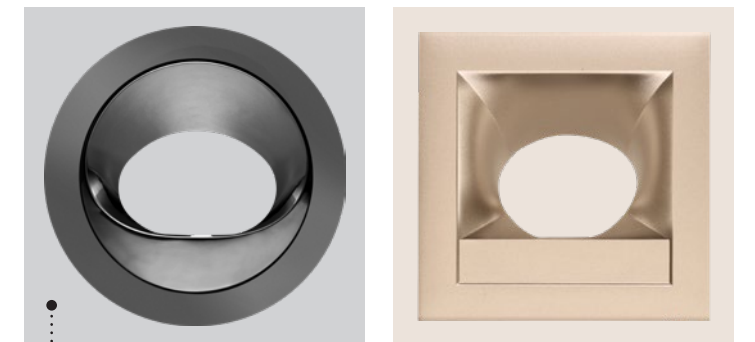

Visual comfort is further enhanced with the option of Dark Chrome and Satin Wheat bezels, which absorb glare and make the luminaire appear unlit.

04

Efficient Optics – 90% of Light Targeting Wall

Invisio's exceptional optical precision is crucial for directing light accurately onto the wall, translating into a significant energy advantage by ensuring that between 80% and 90% of light is directed where it's needed most — on the wall, not the floor — with only 0.3 W/sqft of power needed for each 10fc of average illuminance on the wall.

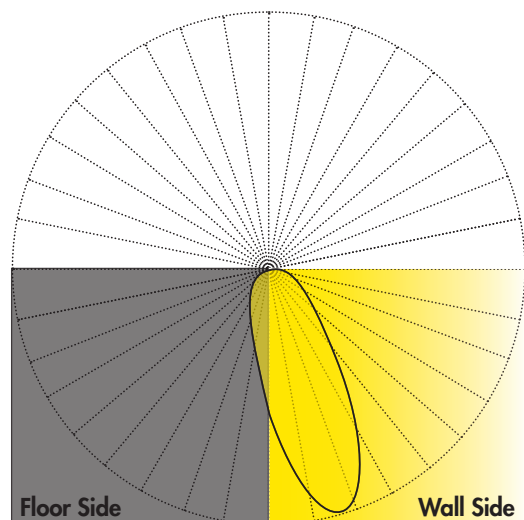

**Invisio Puts 80-90%
of Light on the Wall,
Not the Floor**





05

Greater Spacing and Cost Effectiveness

The Invisio Wallwash is a game-changer, achieving an impressive 3:1 uniformity with generous spacing and lower lumens, thanks to our precision optical engineering. By focusing light directly onto the wall, Invisio delivers maximum energy savings without sacrificing performance, giving you the edge of doing more with fewer fixtures.

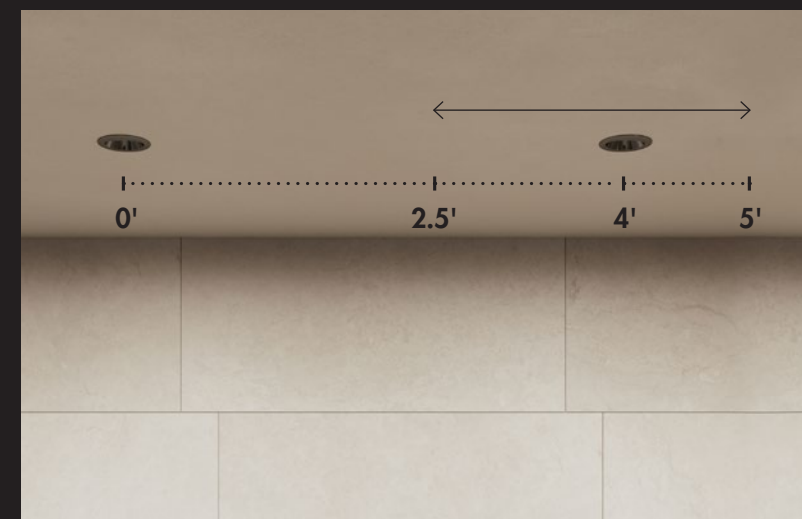



Lumencore Design

Experience a delight for both your eyes and mind with Lumenpulse's premium advantages.

The one-piece heatsink extends lifetime and enables superior performance in every application, boasting impressive lifetimes of 225,000 hours (L70), 55,000 hours (L95), and outputs reaching up to 2000lm.

1. Heatsink – Extends lifetime and enables superior performance.
2. Fixing Ring
3. Standard Invisio Wallwash Bezel
4. Invisio Optic – Deep lens tilt minimizes visible appearance of fixture for enhanced visual comfort.
5. Ceiling Mounting Ring – Easy and quick to install.
6. Trim – The Rollover trim option allows for clean, seamless design with no parting lines.

The Science of Precision

The Invisio optic, meticulously crafted by our in-house team, is engineered to produce an exceptional wallwash effect. Here's how it works:

Light enters a specialized optic consisting of four distinct elements, each aimed at a designated section of the wall. Element (1) focuses on the bottom third, (2) on the middle, and (3) on the upper third. Meanwhile, Element (4) employs an anidolic principle to capture and emit residual light, illuminating the topmost part of the wall at a shallow angle. Additionally, a recessed optic (5) at a 45° steep angle shields viewers from glare, ensuring a comfortable experience.

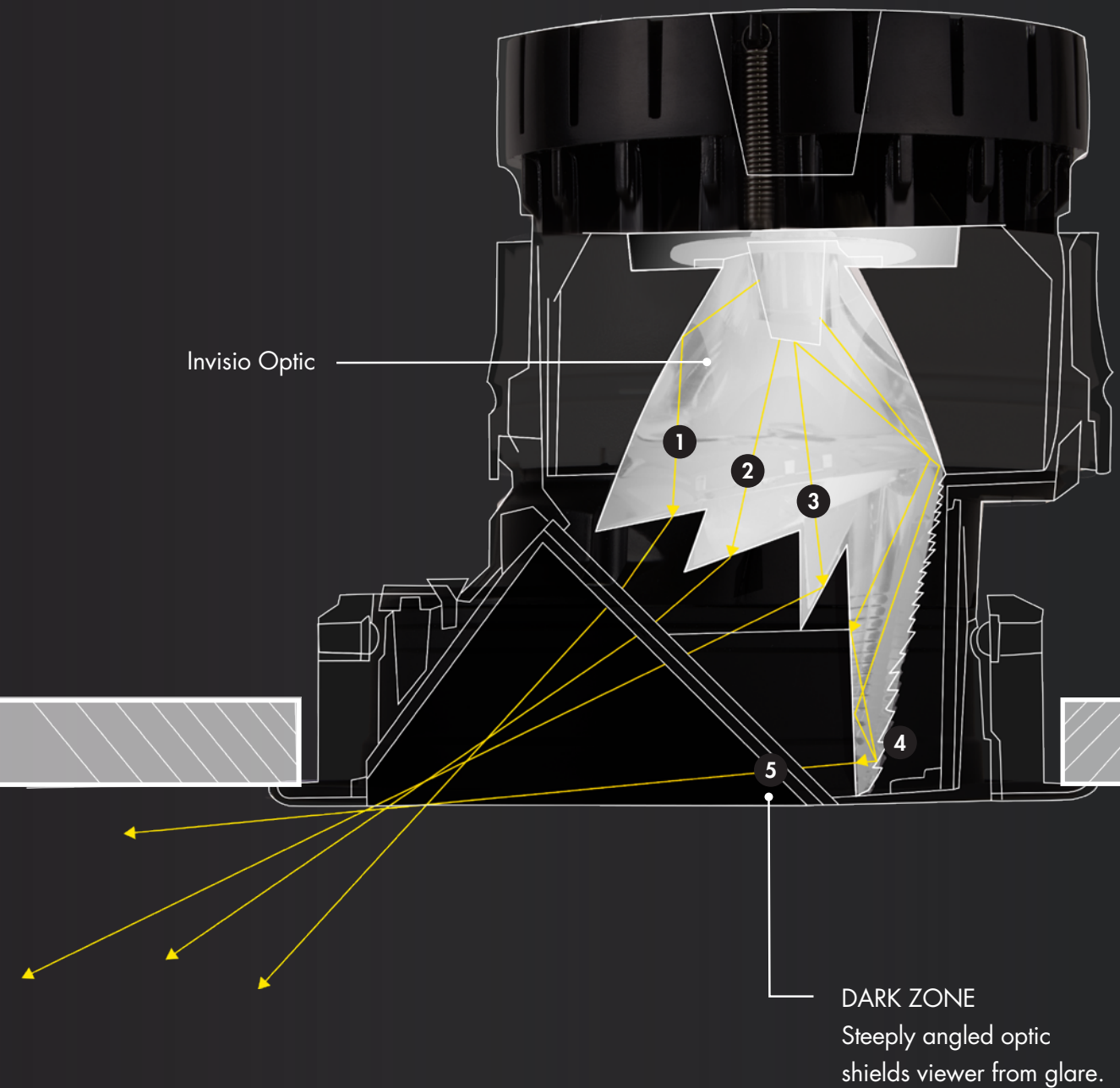

Finishes

The Lumencore Recessed Invisio Wallwash bezel finishes are not just a choice but a statement. Whether seamlessly blending into your design or adding a touch of flair, our Rollover and Standard bezels offer a range of exquisite finishes to suit your style.



BRIGHT CHROME
Rollover Bezel

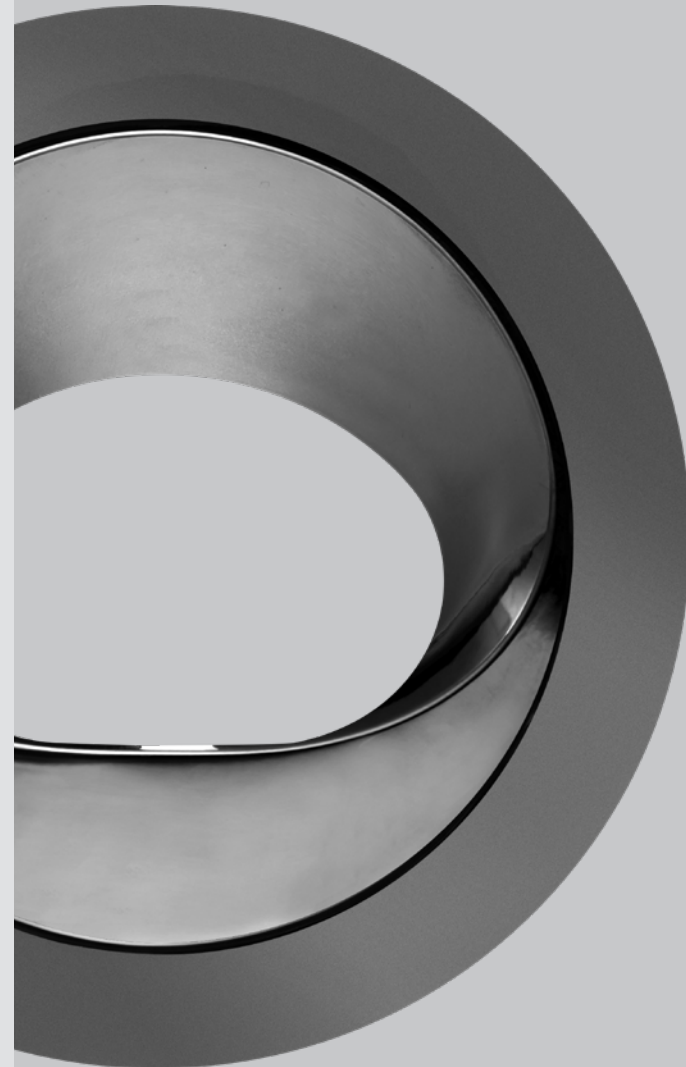

DARK CHROME
Rollover Bezel

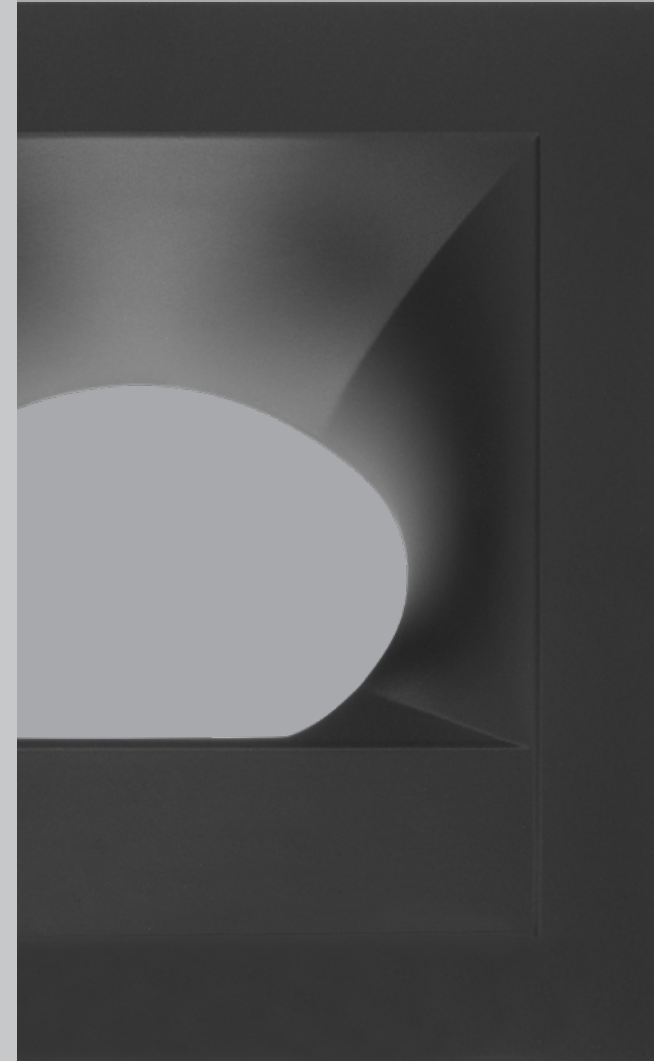

MATTE BLACK
Rollover Bezel



SATIN WHEAT
Rollover Bezel

A Crayon Box of Options

Optics



Invisio Wallwash

Trim Shapes

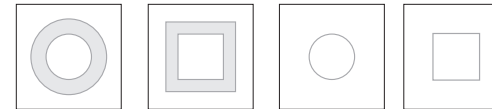

Round Square Round Trimless Square Trimless

Bezel Options



Round Trim Invisio Wallwash Round Trim Invisio Rollover Wallwash Square Trim Invisio Wallwash Square Trim Invisio Rollover Wallwash

Trim Colors



Matte White Matte Black Nickel Satin Custom Color Special Color PS

Bezel Colors



Matte White Matte Black Nickel Satin Bright Chrome Dark Chrome



Satin Wheat Champagne Gold Custom Color Special Color PS

Sizes



Nano Small

Outputs

700lm | 1000lm
1300lm | 2000lm

Color Temperatures

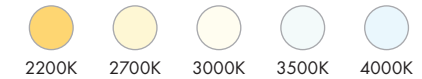

Color Rendering Options

80+ | 90+ | 95+

Control Options

- On/Off Control
- 0-10V 1% or Pro 0-10V 0.1% (linear or logarithmic)
- Phase Dimming
- Pro Phase Dimming 1%
- Lutron® Hi-Lume Premier 0.1% EscoSystem® PEQO Softon/Fade-to-Black
- Lutron® Vive
- nLight®, nLight® Emergency
- DALI 1% or Pro DALI 0.1% (linear or logarithmic)
- DALI-2 Type 8
- DMX/RDM
- lumen talk



NOTE: Some exceptions, consult specification sheets for details.



Applications & Inspiration



Standard Room Height

The Invisio provides remarkable flexibility regarding spacing criteria. Opt for a 2.5ft interval equal to the setback, ensuring outstanding uniformity and brightness. Or, set spacing at 4ft (1.6x the setback) to reduce the number of fixtures by 37%, maintaining excellent uniformity with a modest effect on average illuminance.

Wall Height 10' | Width 20'



Uniformity
2.75 to 1
(Max/Min)

Best Uniformity

- Illuminance: 20.6 fc (avg.)
- Spacing on Center: 2.5'
- Setback: 2.5'
- Fixtures: 8

Wall Height 10' | Width 20'



Uniformity
3.8 to 1
(Max/Min)

Economic Efficiency

- Illuminance: 12.9 fc (avg.)
- Spacing on Center: 4'
- Setback: 2.5'
- Fixtures: 5

High Ceiling

Illuminate your high ceiling space with precision and elegance using the Invisio Wallwash, unlocking a realm of advantages. Achieve impeccable uniformity across the entire vertical expanse, ensuring every corner is bathed in consistent, glare-free light. Experience complete wall coverage from ceiling to floor, with no light spill on the floor, showcasing architectural details and enhancing the ambiance of your space. Elevate your high ceiling area with the unmatched performance and versatility of the Invisio Wallwash.

Wall Height 16' | Width 20'

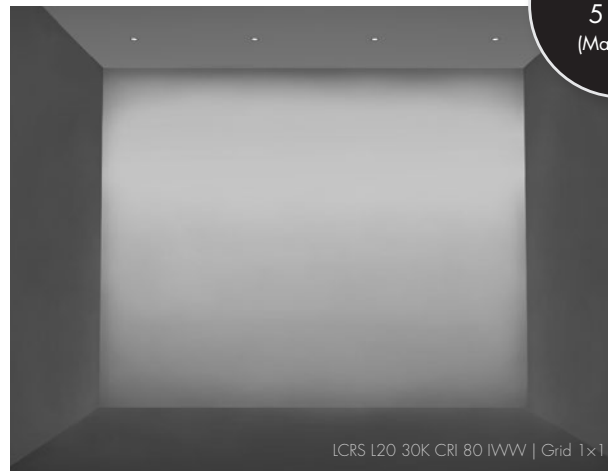

Uniformity
5 to 1
(Max/Min)

Two-Story Height

- Illuminance: 10 fc (avg.)
- Spacing on Center: 4'
- Setback: 4'
- Fixtures: 4





Invisio Achieves

Invisio Wallwash eliminates the typical challenges associated with LED wallwashing. True uniformity, absolute efficiency, and precision optics ensure complete visual comfort and subject coverage.

WALLWASH PROBLEMS

- ✗ Heavy scalloping →
- ✗ Hotspots or uneven illumination →
- ✗ Glare or visual discomfort →
- ✗ Light misdirected to the floor →
- ✗ Too many luminaires in the ceiling →

INVISIO SOLUTIONS

- ✓ Light to the Ceiling
- ✓ All the Wall Uniformity
- ✓ Outstanding Visual Comfort
- ✓ Efficiently Targets Wall
- ✓ Generous Spacing Ratios

Sales Offices and Manufacturing Facilities

Corporate Headquarters

1220 Marie-Victorin Blvd.
Longueuil, QC
J4G 2H9 Canada

T +1.877.937.3003
T +1.514.937.3003
F +1.514.937.6289

Boston, United States

14 Beacon Street, 3rd Floor
Boston, MA
02108 United States

T +1.877.937.3003
T +1.617.307.5700
F +1.617.350.9912

